

IPv6 Security



ISP Workshops

Before we begin...

- Enabling IPv6 on any device means that:
 - The device is accessible by IPv6
 - Interface filters and firewall rules already present in IPv4 **must** be replicated for IPv6
 - Router vty filters already present in IPv4 **must** be replicated for IPv6
- Failure to protect the device after enabling IPv6 means that it is wide open to abuse through IPv6 transport
 - Even though the IPv4 security is in place

Agenda

- ❑ Should I care about IPv6?
- ❑ Issues shared by IPv4 and IPv6
- ❑ Issues specific to IPv6
- ❑ Enforcing a Security Policy in IPv6
- ❑ Secure IPv6 transport over public network
- ❑ IPv6 Security Best Practices

Should I care?

- Is IPv6 in my IPv4 network?
 - Yes!
 - And it is easy to check too
- Look inside IPv4 NetFlow records
 - Protocol 41: IPv6 over IPv4 or 6to4 tunnels
 - IPv4 address: 192.88.99.1 (6to4 anycast server)
 - UDP 3544, the public part of Teredo, yet another tunnel
- Look into DNS requests log for 'ISATAP'

uTorrent 1.8

- Uses IPv6 by default – released August 2008

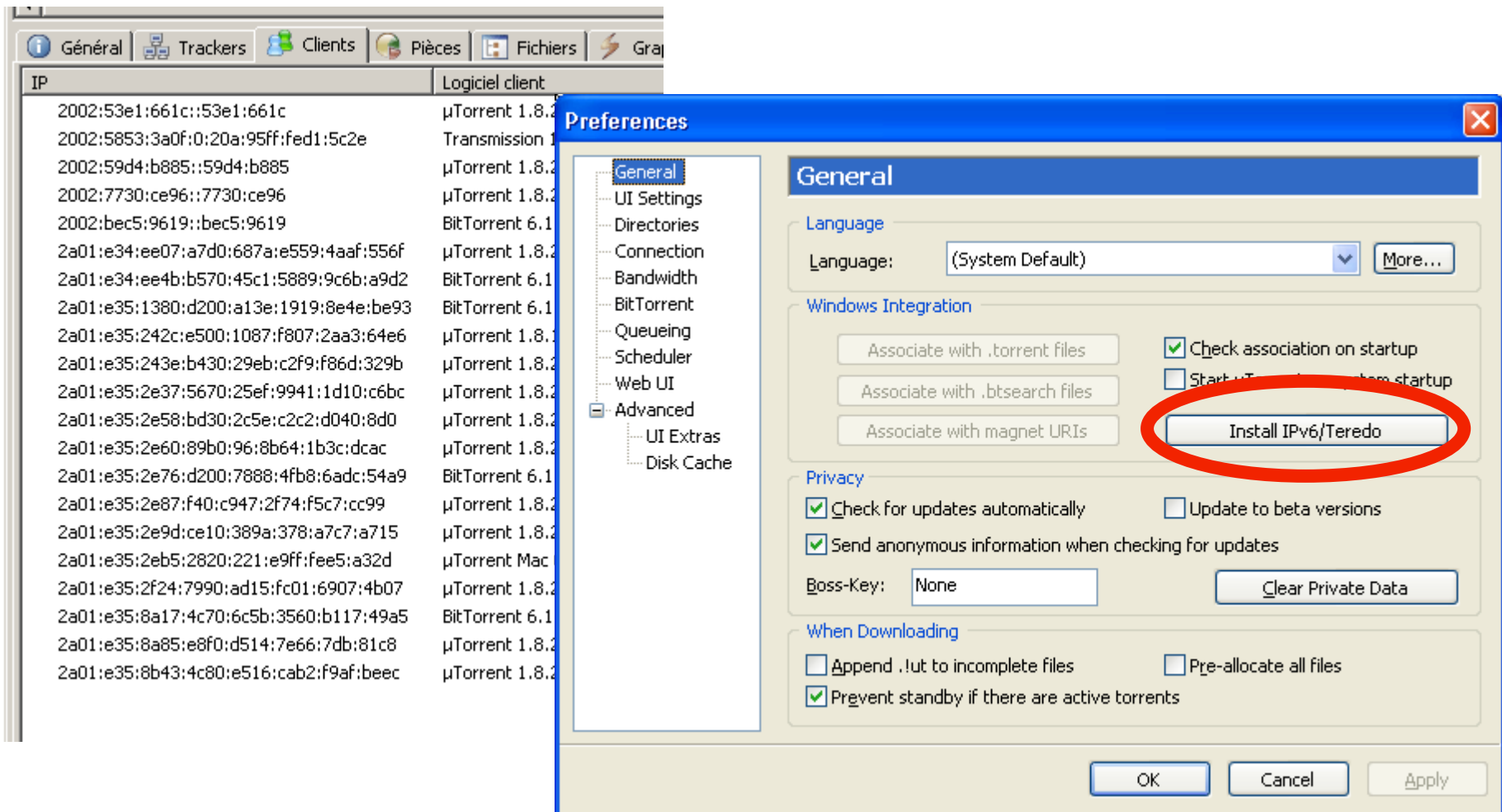

Should I care?

- ❑ **Yes, because your end users are already using IPv6**
- ❑ Some transition techniques are aggressive about using IPv6
- ❑ Plus users knowingly configuring IPv6 because “IT” have decided not to supply it by default
 - 6to4 – IPv6 automatic tunnel through IPv4
 - Teredo – tunnel IPv6 through UDP to bypass firewalls and NATs
 - ISATAP – tunnel between IPv6 nodes within organisations
 - GRE or IPv6 in IP tunnels

Should I care?

- Yes, because some operating systems:
 - Have IPv6 turned on by default
 - (most modern OSes)
 - Use IPv6 for administrative communications between devices
 - Windows Server 2008 & 2012, Exchange 2010 etc
- Turning IPv6 off for some of these operating systems actually harms their function and performance
 - Don't do it, even if you think it might be a good idea
- (Yes, this IPv6 deployment by stealth)

Issues shared by IPv4 and IPv6



Issues facing IPv4 that we can
find in IPv6...



Issues shared by IPv4 and IPv6

- ❑ Scanning methods
- ❑ Viruses and Worms
- ❑ Filtering
- ❑ Amplification attacks
- ❑ Layer-2 attacks
- ❑ Broadcasts
- ❑ Routing Authentication
- ❑ Hacking

Scanning

- Default subnets in IPv6 have 2^{64} addresses
 - 10 Mpps = more than 50 000 years to scan
 - But different scanning techniques will be used
 - Miscreants will use more intelligent methods for harvesting reachable addresses
- Public servers will still need to be DNS reachable
 - AAAA entries in the DNS
 - More information collected by Google...
 - Tools like SensePost's BiDiBLAH (now replaced by Yeti)
- Administrators usually adopt easy-to-remember addresses
 - Easy to remember: `::10`, `::F00D`, `::CAFE`, `::FADE` etc
 - Insert the interface's IPv4 address into the last 32 bits of the interface's IPv6 address

Scanning

- ❑ Network administrators pick short/simple addresses for infrastructure devices:
 - e.g Loopbacks on 2001:db8::1, 2001:db8::2, etc
- ❑ By compromise of hosts in a network
 - Access to one host gives attackers the chance to discover new addresses to scan
- ❑ Transition techniques (see later) derive IPv6 address from IPv4 address
 - Plenty of opportunities for more scanning

Viruses and Worms in IPv6

- Viruses & worms
 - No change for IPv6
 - Usual transmission techniques such as IM, email etc are higher up the protocol stack
 - Other worms:
 - IPv4: reliance on network scanning
 - IPv6: not so easy using simple scanning ⇒ will use alternative techniques already discussed
- Worm developers will adapt to IPv6
 - IPv4 best practices around worm detection and mitigation remain valid

Overloading the CPU

- ❑ Aggressive scanning can overload router CPU
 - Router will do Neighbour Discovery, wasting CPU and memory
 - Most routers have built-in rate-limiters which help
- ❑ Using a /64 on point-to-point links ⇒ a lot of addresses to scan!
- ❑ Using infrastructure ACL to prevent this scanning
 - Easy with IPv6 because new addressing scheme can be done 😊

DoS Example

Ping-Pong over Physical Point-to-Point

- ❑ Most recent implementations support RFC 4443 so this is not a threat
- ❑ Use of /127 on P2P link recommended (see RFC 6164)
- ❑ Same as in IPv4, on real P2P, "if not for me send it on to the other side", producing looping traffic

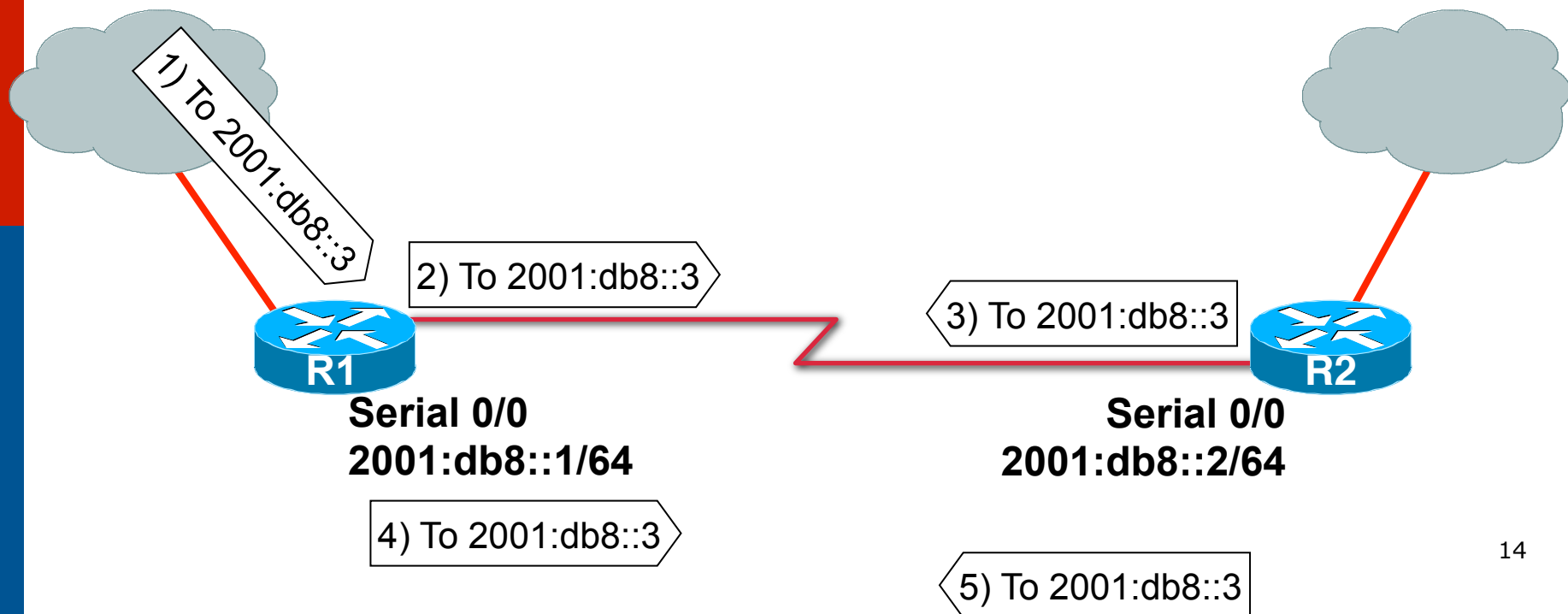

IPv6 Bogon Filtering and Anti-Spoofing

- ❑ IPv6 nowadays has its bogons:
 - www.team-cymru.org/Services/Bogons/http.html
- ❑ Similar situation as for IPv4
 - BCP 38 still applies!
 - ⇒ Same technique = uRPF
 - **Apply towards all end-users**

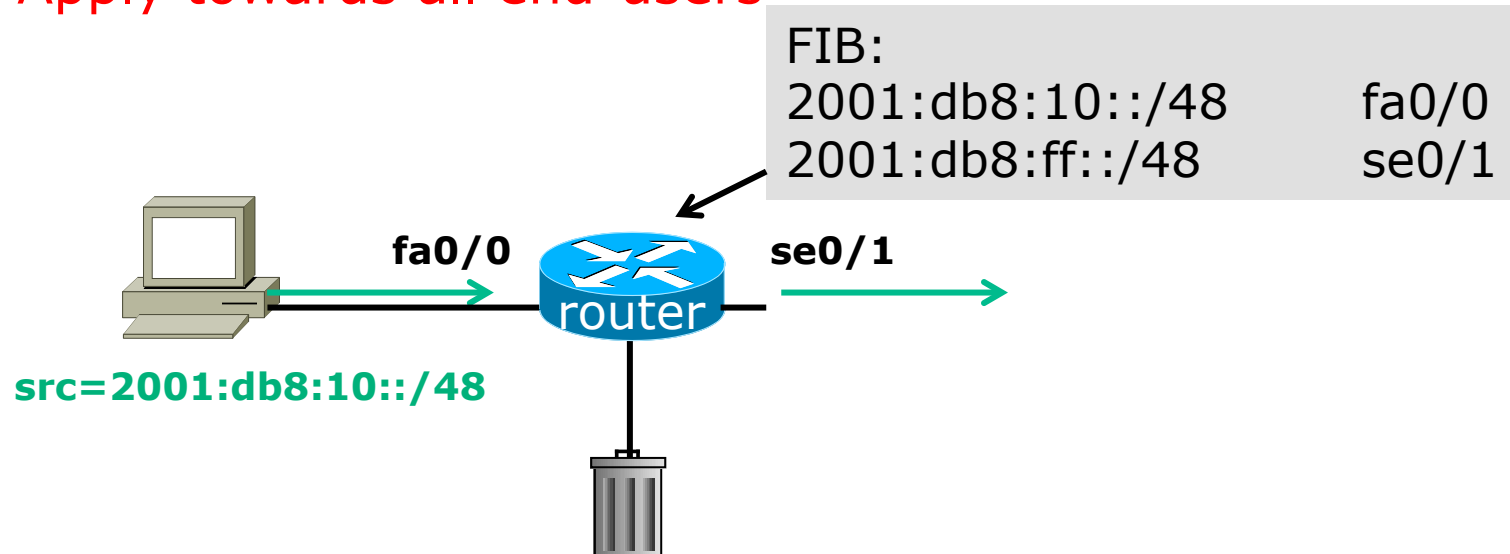

IPv6 Bogon Filtering and Anti-Spoofing

- IPv6 nowadays has its bogons:
 - www.team-cymru.org/Services/Bogons/http.html
- Similar situation as for IPv4
 - BCP 38 still applies!
 - ⇒ Same technique = uRPF
 - **Apply towards all end-users**

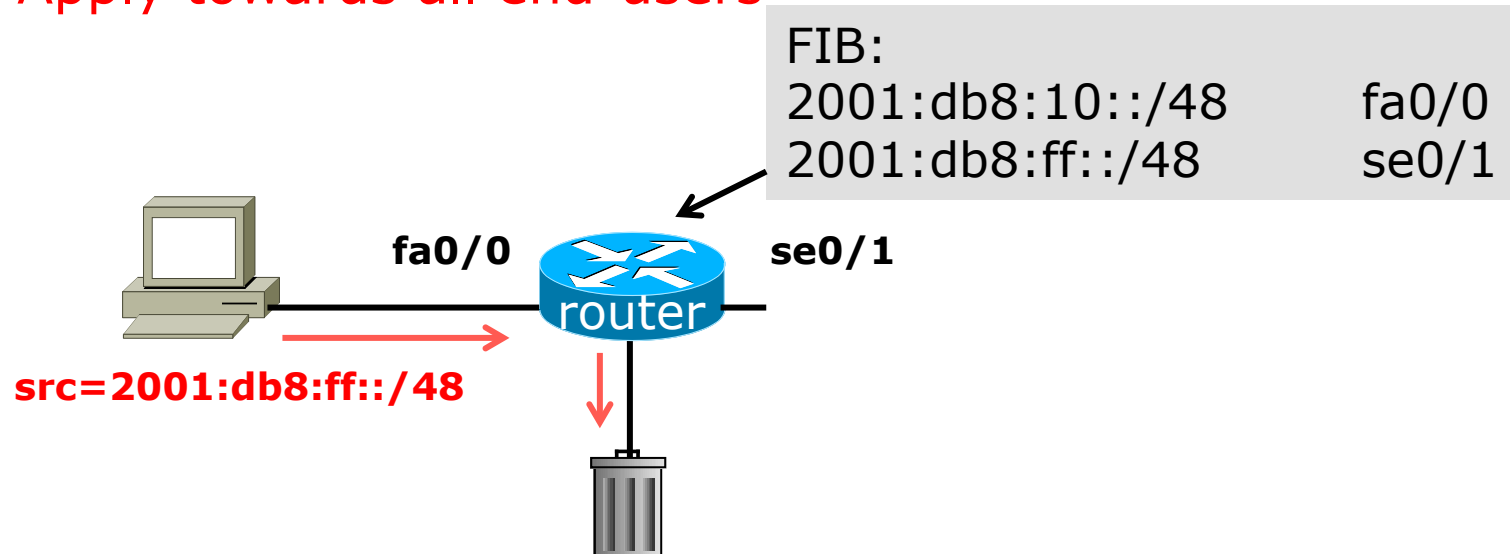

ICMP_{v4} vs. ICMP_{v6}

- ❑ Significant changes from IPv4
- ❑ ICMP is relied on much more

| ICMP Message Type | ICMPv4 | ICMPv6 |
|-----------------------------------|--------|--------|
| Connectivity Checks | X | X |
| Informational/Error Messaging | X | X |
| Fragmentation Needed Notification | X | X |
| Address Assignment | | X |
| Address Resolution | | X |
| Router Discovery | | X |
| Multicast Group Management | | X |
| Mobile IPv6 Support | | X |

- ❑ ICMP policy on firewalls needs fundamental rethink

Generic ICMPv4

Border Firewall Policy

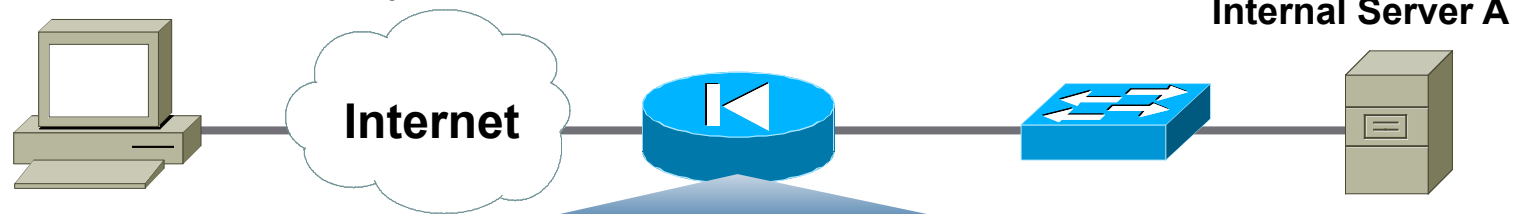

| Action | Src | Dst | ICMPv4 Type | ICMPv4 Code | Name |
|--------|-----|-----|-------------|-------------|--------------------------------------|
| Permit | Any | A | 0 | 0 | Echo Reply |
| Permit | Any | A | 8 | 0 | Echo Request |
| Permit | Any | A | 3 | 0 | Dst. Unreachable— Net Unreachable |
| Permit | Any | A | 3 | 4 | Dst. Unreachable— Frag. Needed |
| Permit | Any | A | 11 | 0 | Time Exceeded— TTL Exceeded |

Equivalent ICMPv6

RFC 4890: Border Firewall Transit Policy

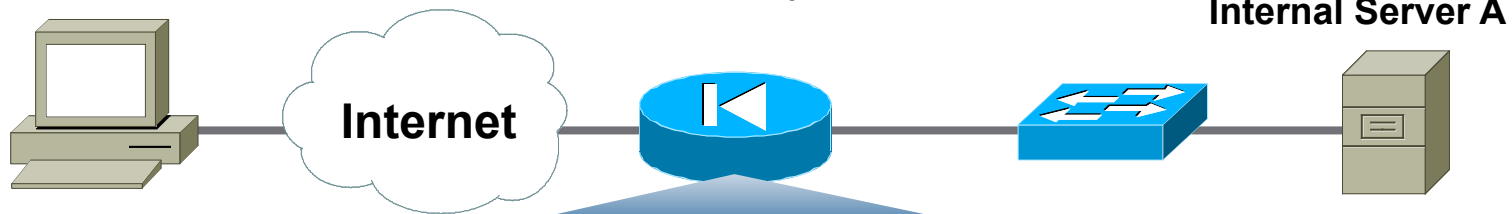

| Action | Src | Dst | ICMPv6 Type | ICMPv6 Code | Name |
|--------|-----|-----|-------------|-------------|--------------------------------|
| Permit | Any | A | 128 | 0 | Echo Reply |
| Permit | Any | A | 129 | 0 | Echo Request |
| Permit | Any | A | 1 | 0 | No Route to Dst. |
| Permit | Any | A | 2 | 0 | Packet Too Big |
| Permit | Any | A | 3 | 0 | Time Exceeded— TTL Exceeded |
| Permit | Any | A | 4 | 0 | Parameter Problem |

Equivalent ICMPv6

RFC 4890: Border Firewall Receive Policy

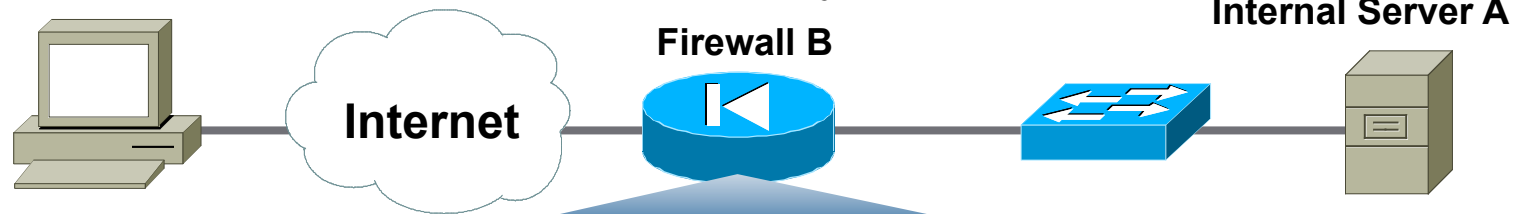

| Action | Src | Dst | ICMPv6 Type | ICMPv6 Code | Name |
|--------|-----|-----|-------------|-------------|---|
| Permit | Any | B | 2 | 0 | Packet too Big |
| Permit | Any | B | 4 | 0 | Parameter Problem |
| Permit | Any | B | 130-132 | 0 | Multicast Listener |
| Permit | Any | B | 133/134 | 0 | Neighbor Solicitation and Advertisement |
| Deny | Any | Any | | | |

For locally generated traffic

IPv6 Routing Header

- An extension header
- Processed by the listed intermediate routers
- Two types
 - Type 0: similar to IPv4 source routing (multiple intermediate routers)
 - Type 2: used for mobile IPv6 (single intermediate router)

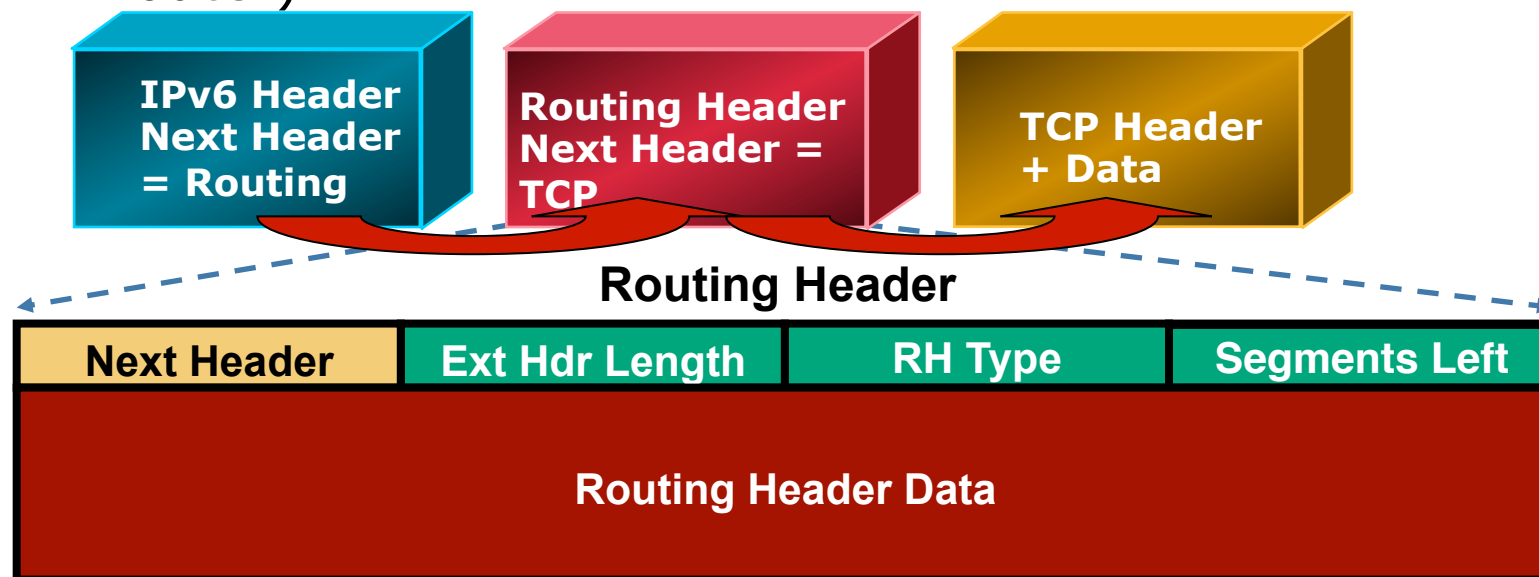

Type 0 Routing Header Amplification Attack

- ❑ What if attacker sends a packet with a Routing Header containing
 - $A \rightarrow B \rightarrow A \rightarrow B \rightarrow A \rightarrow B \rightarrow A \rightarrow B \rightarrow A \dots$
- ❑ Packet will loop multiple times on the link R1-R2
- ❑ An amplification attack!

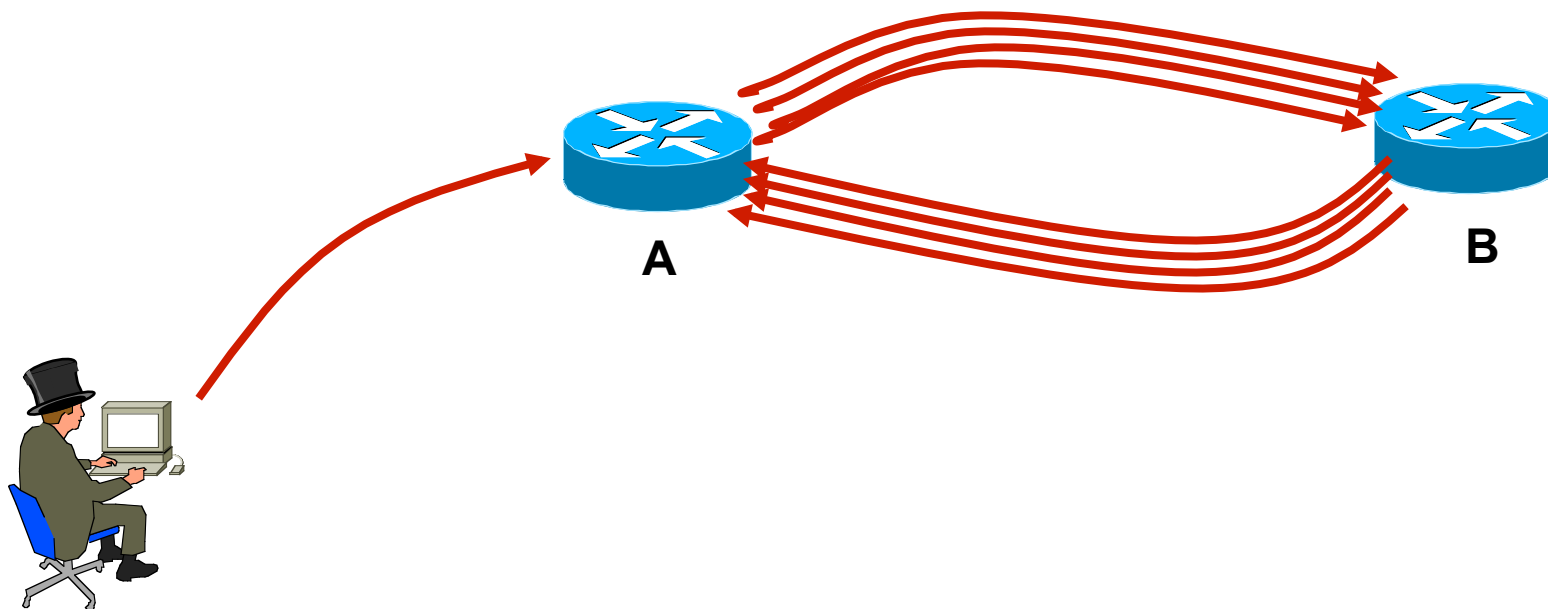

Preventing Routing Header Attacks

- ❑ Apply same policy for IPv6 as for IPv4:
 - Block Routing Header type 0
- ❑ Prevent processing at the intermediate nodes
 - `no ipv6 source-route`
 - Windows, Linux, Mac OS: default setting
- ❑ At the edge
 - With an ACL blocking routing header type 0
- ❑ RFC 5095 (Dec 2007) RH0 is deprecated
 - Cisco IOS default changed in 12.4(15)T: no need to type `'no ipv6 source-route'`

Threats on the Layer-2 Link

- IPv4 has several threats against layer-2
 - ARP spoofing
 - Rogue DHCP
 - ...

- What about IPv6?
 - On WLAN hotspot
 - On ETTx network
 - On hosting service Data Center
 - On ADSL/cable aggregation

ARP Spoofing is now NDP Spoofing

- ❑ ARP is replaced by Neighbor Discovery Protocol
 - Nothing authenticated
 - Static entries overwritten by dynamic ones
- ❑ Stateless Address Autoconfiguration
 - Rogue RA (malicious or not)
 - Node misconfiguration
 - ❑ DoS
 - ❑ Traffic interception (Man In the Middle Attack)
- ❑ Attack tools exist (from THC – The Hacker’s Choice)
 - Parasit6
 - Fakerouter6
 - ...

ARP Spoofing is now NDP Spoofing

- ❑ **BAD NEWS:** nothing like dynamic ARP inspection for IPv6
 - Will require new hardware on some platforms
- ❑ **GOOD NEWS:** Secure Neighbor Discovery (RFC3971)
 - SEND = NDP + crypto
 - But not supported by Windows yet!
 - Crypto means slower...
 - NDPmon toolset (NDP Monitor)
- ❑ **GOOD NEWS:** RA Guard (RFC6105)
 - Superset of SEND
 - Permits RAs based on a set of criteria
- ❑ More **GOOD NEWS:**
 - Private VLAN works with IPv6
 - Port security works with IPv6
 - 802.1X works with IPv6
 - DHCP-PD means no need for NDP-proxy

IPv6 and Broadcasts

- ❑ There are no broadcast addresses in IPv6
- ❑ Broadcast address functionality is replaced with appropriate link local multicast addresses

| | |
|----------------------------------|---------|
| Link Local All Nodes Multicast | FF02::1 |
| Link Local All Routers Multicast | FF02::2 |
| Link Local All mDNS Multicast | FF02::F |

Anti-spoofing also blocks amplification attacks because a remote attacker cannot masquerade as his victim

Preventing IPv6 Routing Attacks: Protocol Authentication

- ❑ BGP, ISIS, EIGRP no change:
 - MD5 authentication of the routing update
- ❑ OSPFv3 is different from OSPFv2
 - MD5 authentication dropped from the protocol
 - Authentication relies on transport mode IPsec
- ❑ RIPng and PIM also rely on IPsec
- ❑ IPv6 routing attack prevention best practices
 - Use traditional authentication mechanisms on BGP and IS-IS
 - Use IPsec to secure protocols such as OSPFv3 and RIPng

OSPFv3 & EIGRP Authentication

□ OSPFv3:

```
ipv6 router ospf 30
  area 0 authentication ipsec spi 256 md5
    1234567890ABCDEF1234567890ABCDEF
```

□ EIGRP:

```
interface Ethernet0/0
  ipv6 authentication mode eigrp 100 md5
  ipv6 authentication key-chain eigrp 100 MYCHAIN
  !
key chain MYCHAIN
  key 1
    key-string my-eigrp-pw
```

BGP and ISIS Authentication

□ BGP:

```
router bgp 10
  address-family ipv6
    neighbor 2001:db8::4 remote-as 11
    neighbor 2001:db8::4 password bgp-as11-pw
```

□ ISIS:

```
interface Serial0/0
  isis authentication mode md5
  isis authentication key-chain MYCHAIN
!
key chain MYCHAIN
  key 1
    key-string my-isis-pw
```

IPv6 Attacks with Strong IPv4 Similarities

- **Sniffing**
 - Without IPSec, IPv6 is as vulnerable to sniffing as IPv4
- **Application layer attacks**
 - The majority of vulnerabilities on the Internet today are at the application layer, something that IPSec will do nothing to prevent
- **Rogue devices**
 - Rogue devices will be as easy to insert into an IPv6 network as in IPv4
- **Man-in-the-Middle Attacks (MITM)**
 - Without strong mutual authentication, any attacks utilizing MITM will have the same likelihood in IPv6 as in IPv4
- **Flooding**
 - Flooding attacks are identical between IPv4 and IPv6

By the Way: It Is Real ☹️

IPv6 Hacking/Lab Tools

- ❑ Sniffers/packet capture
 - Snort
 - TCPdump
 - Sun Solaris snoop
 - COLD
 - Wireshark
 - Analyzer
 - Windump
 - WinPcap
- ❑ DoS Tools
 - 6tunneldos
 - 4to6ddos
 - Imps6-tools
- ❑ Scanners
 - IPv6 security scanner
 - Halfscan6
 - Nmap
 - Strobe
 - Netcat
- ❑ Packet forgers
 - Scapy6
 - SendIP
 - Packit
 - Spak6
- ❑ Complete toolkit
 - www.thc.org/thc-ipv6/

Specific IPv6 issues



New IPv6 features introduce
new problems...



Specific IPv6 Issues

- ❑ IPv6 header manipulation
- ❑ Link Local vs Global Addressing
- ❑ Transition Challenges
- ❑ 6to4, 6VPE
- ❑ v4/v6 translation issues
- ❑ IPv6 stack issues

IPv6 Header Manipulation

- ❑ Unlimited size of header chain (spec-wise) can make filtering difficult
- ❑ Potential DoS with poor IPv6 stack implementations
 - More boundary conditions to exploit
 - Can I overrun buffers with a lot of extension headers?

The image shows a Wireshark packet capture window. The packet list pane on the left shows the following structure:

- Frame 1 (423 bytes on wire, 423 bytes captured)
- Raw packet data
- Internet Protocol Version 6
- Hop-by-hop Option Header
- Destination Option Header
- Routing Header, Type 0
- Hop-by-hop Option Header
- Destination Option Header
- Routing Header, Type 0
- Destination Option Header
- Routing Header, Type 0
- Transmission Control Protocol, Src Port: 1024 (1024), Dst Port: bgp (179), Seq: 0, Ack: 0, Len: 51
- Border Gateway Protocol

Annotations on the right side of the image:

- Perfectly Valid IPv6 Packet According to the Sniffer** (points to the entire packet structure)
- Header Should Only Appear Once** (points to the first Hop-by-hop Option Header)
- Destination Header Which Should Occur at Most Twice** (points to the first and second Destination Option Headers)
- Destination Options Header Should Be the Last** (points to the last Destination Option Header)

Red circles highlight the Hop-by-hop Option Header and the three Destination Option Headers. Red arrows point from the text boxes to the corresponding headers in the packet list.

Parsing the Extension Header Chain

- Finding the layer 4 information is not trivial in IPv6
 - Skip all known extension header
 - Until either known layer 4 header found ⇒ **SUCCESS**
 - Or unknown extension header/layer 4 header found... ⇒ **FAILURE**



Fragment Header: IPv6

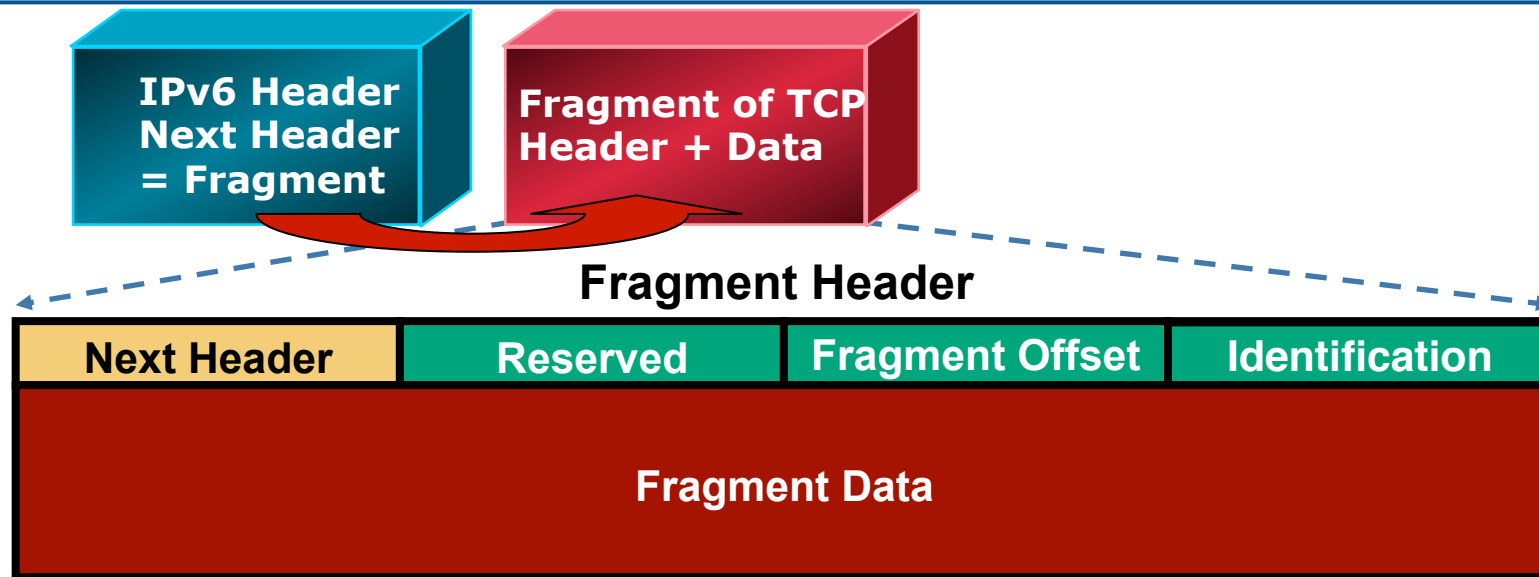

- ❑ According to the IPv6 RFC, fragmentation is only done by the end system
 - But in some cases, routers act as an end system
- ❑ Reassembly done by end system like in IPv4
- ❑ Attackers can still cause fragmentation in end/intermediate systems
 - A great obfuscation tool to hide attacks on IPS & firewall

Parsing the Extension Header Chain

Fragmentation Matters!

- ❑ Extension headers chain can be so large that the header itself is fragmented!
- ❑ Finding the layer 4 information is not trivial in IPv6
 - Skip all known extension headers
 - Until either known layer 4 header found ⇒ **SUCCESS**
 - Or unknown extension header/layer 4 header found ⇒ **FAILURE**
 - Or end of extension headers ⇒ **FAILURE**

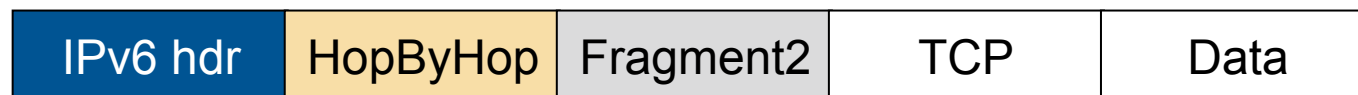

Layer 4 header is
in 2nd fragment

IPv6 Fragments

- Unlimited size of the extension header chain is a source of potential problems
- Recommendation is to block all IPv6 fragments on perimeter filters:
 - E.g. for Cisco IOS:

```
ipv6 access-list border-acl-in
...
deny ipv6 any any fragments
...
```

Link-Local vs. Global Addresses

- ❑ Link-Local addresses (FE80::/10) are isolated
 - Cannot reach outside of the link
 - **Cannot be reached from outside of the link 😊**
- ❑ Could be used on the infrastructure interfaces
 - Routing protocols (including BGP) work with LLA
 - Benefit: no remote attack against your infrastructure
 - ❑ Implicit infrastructure ACL
 - Note: need to provision loopback for ICMP generation
 - LLA can be configured statically (not the EUI-64 default) to avoid changing neighbour statements when changing MAC

IPv6 Transition Technologies Security



From IPv4 to IPv6, securely

Actively deployed Transition Technologies

- Dual stack
- Generic Tunnels
- 6to4
- ISATAP
- Teredo
- NAT64 (and NAT)
- 6rd
- DS-Lite
- 464XLAT
- 6PE & 6VPE

IPv4 to IPv6 Transition Challenges

- ❑ Many competing methods, several may be deployed at the same time
- ❑ Dual stack
 - Consider security for both protocols
 - Cross v4/v6 abuse
 - Resiliency (shared resources)
- ❑ Tunnels
 - Bypass firewalls (protocol 41 or UDP)
 - Bypass other inspection systems
 - Render Netflow blind
 - Traffic engineering becomes tough
 - Asymmetrical flows (6to4)

Dual Stack with IPv6 on by Default

- Your host:
 - IPv4 is protected by your favorite personal firewall...
 - IPv6 is enabled by default (Windows, Linux, Mac OS/X, ...)
- Your network:
 - Does not run IPv6
- Your assumption:
 - I'm safe
- Reality
 - You are not safe
 - Attacker sends Router Advertisements
 - Your host silently configures IPv6
 - You are now under IPv6 attack
- ⇒ Probably time to think about IPv6 in your network

Dual Stack Host Considerations

- Host security on a dual-stack device
 - Applications can be subject to attack on both IPv6 and IPv4
 - **Fate sharing: connectivity is as secure as the least secure stack...**
- Host security controls **must** filter and inspect traffic from both IP versions
 - Host intrusion prevention, personal firewalls, VPN clients, etc.

Split Tunnelling on VPNs

- VPNs are especially vulnerable:
 - Split tunneling
 - IPv4 traffic goes over the IPSEC Tunnel, but
 - IPv6 traffic goes native, and is potentially vulnerable
 - IPv6 host is vulnerable to incoming exploits

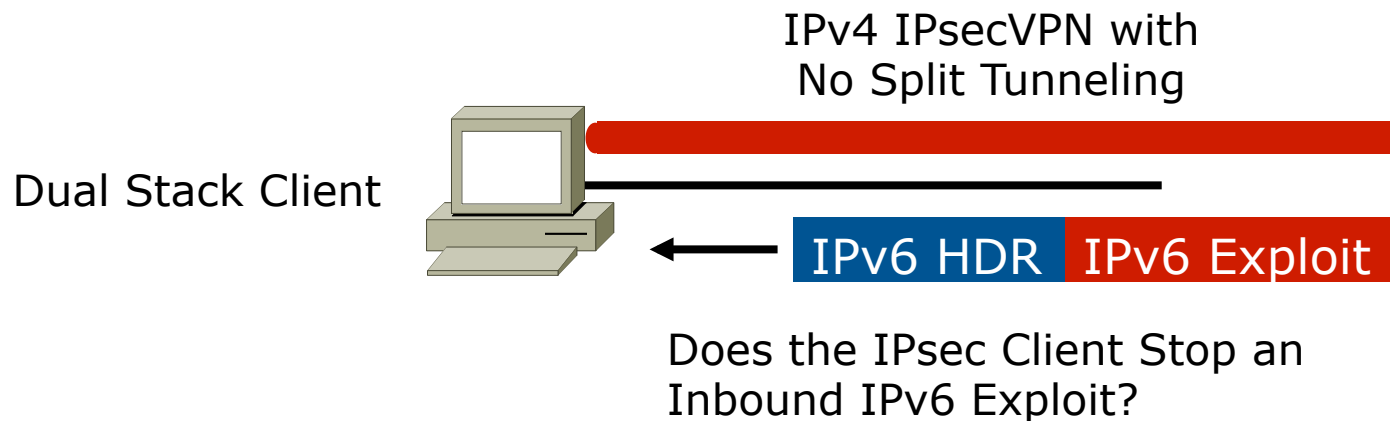

How to block Rogue Tunnels?

- ❑ Rogue tunnels by naïve users:
 - Sure, block IP protocol 41 and UDP/3544
 - In Windows:

```
netsh interface 6to4 set state state=disabled undoonstop=disabled
netsh interface isatap set state state=disabled
netsh interface teredo set state type=disabled
```

- ❑ Really rogue tunnels (covert channels)
 - No easy way...
 - Teredo will run over a different UDP port of course
- ❑ Deploying native IPv6 (including IPv6 firewalls and IPS) is best/easier alternative
- ❑ Or disable IPv6 (uh?)

6to4 Issues

- ❑ Automatic tunnelling technology
- ❑ Bypasses filters, firewalls, most intrusion detection systems
- ❑ Two components:
 - 6to4 client
 - 6to4 relay
- ❑ 6to4 host might be IPv4 protected – what about IPv6 protection, filters,...?
- ❑ 6to4 relay
 - 6to4 host picks topologically closest relay
 - Outbound traffic – your ISP's relay
 - Return traffic – whose relay??

6to4 Tunnels Bypass Filters

- 6to4 tunnel to another 6to4 host on local network
 - Results in IPv6 packets going from one IPv6 host to another IPv6 over IPv4
 - Bypasses IPv6 packet filters on central host
 - Bypasses IPv4 packet filters on central host
 - ⇒ Major security risk

6to4 Tunnels Bypass Filters

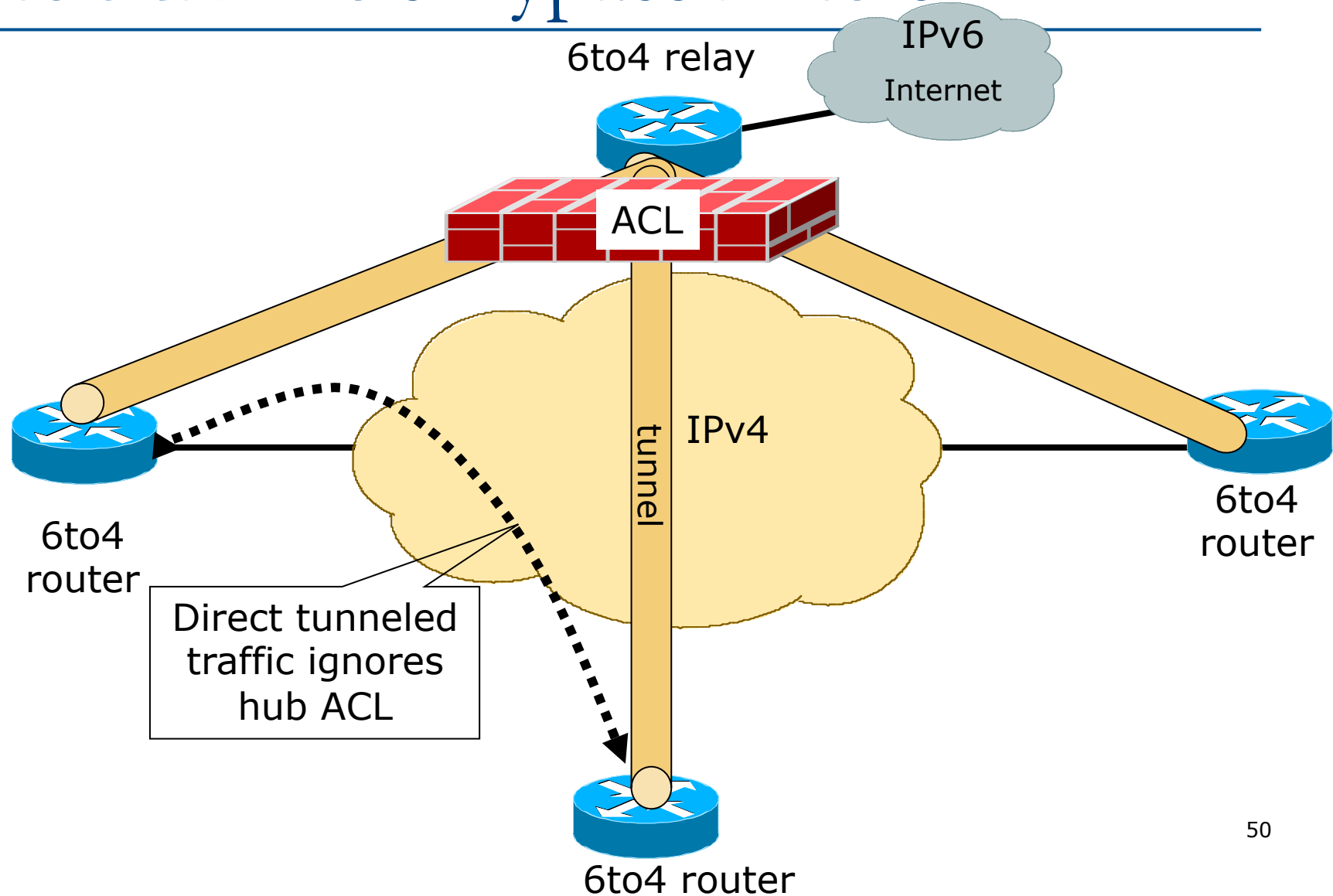

6to4 Relay Security Issues

- Traffic injection & IPv6 spoofing
 - Prevent spoofing by applying uRPF check
 - Drop 6to4 packets whose addresses are built on IPv4 bogons
 - Loopback
 - RFC 1918
- Redirection and DoS
 - Block most of the ICMPv6 traffic:
 - No Neighbor Discovery
 - No link-local traffic
 - No redirect

6to4 Relay Security Issues

- Traffic is asymmetric
 - 6to4 client/router → 6to4 relay → IPv6 server:
 - Client IPv4 routing selects the relay
 - IPv6 server → 6to4 relay → 6to4 client/router:
 - Server IPv6 routing selects the relay
 - Cannot insert a stateful device (firewall, ...) on any path
- Potential amplification attack (looping IPv6 packet) between ISATAP server & 6to4 relay
 - Where to route: 2002:isatap::/48 ?
 - Where to route: isatap_prefix::200:5efe:6to4?

ISATAP issues

- Intra-site tunneling protocol
 - Designed to let isolated IPv6 clients speak to other isolated IPv6 enabled devices over a site's IPv4 infrastructure
- Security considerations:
 - Client IPv6 filtering/firewalling?
 - Tunnel technology could bypass inter-departmental controls used for IPv4
 - Who runs the domain's ISATAP server?

Teredo Issues

- ❑ UDP based tunnelling technology to allow remote IPv6 clients connect to IPv6 Internet over IPv4 infrastructure
 - Uses UDP
 - Bypasses firewalls and traverses NATs
- ❑ Already seen the “bittorrent” case at the start of the presentation
- ❑ Severe security risk for any organisation
 - Client IPv6 filters?
 - Firewall bypass
 - Who runs the remote Teredo relay?
 - Runs on non-default UDP ports too

Translation Issues

- Whether NAT64 or NAT444
- Shared IPv4 address among different subscribers
 - Per-IP address reputation means that bad behaviour by one affects multiple subscribers
 - Sending ICMP Packet-too-big to common server means bandwidth reduction for all subscribers sharing that source IP address
 - Huge amount of log traffic for Lawful Intercept (but there are other ways to keep track)

6rd Issues

- Based on 6to4, so potentially inherits most of 6to4's security considerations
 - Securing IPv6 traffic on 6rd client in the same way as for native IPv4 traffic
- 6rd-relay is controlled by ISP though
 - Avoids "publicly operated" relay problem which plagues 6to4

DS-Lite & 464XLAT Issues

- ISP has native IPv6 backbone
 - And no IPv4
- IPv4 tunnelled through IPv6
- CPE is dual stack towards the end user
 - Usual dual stack security considerations
- ISP core tunnel termination (Large Scale NAT)
 - Faces all the security and scaling considerations that any NAT device would face

6VPE Security Issues

- ❑ 6PE (dual stack without VPN) is a simple case
- ❑ Security is identical to IPv4 MPLS-VPN, see RFC 4381
- ❑ Security depends on correct operation and implementation
 - QoS prevent flooding attack from one VPN to another one
 - PE routers must be secured: AAA, iACL, CoPP ...

6 VPE Security Issues

- MPLS backbones can be more secure than “normal” IP backbones
 - Core not accessible from outside
 - Separate control and data planes
- PE security
 - Advantage: Only PE-CE interfaces accessible from outside
 - Makes security easier than in “normal” networks
 - IPv6 advantage: PE-CE interfaces can use link-local for routing
 - ⇒ completely unreachable from remote (better than IPv4)

IPv6 Security Policies



So how do we go about
securing the network...?

IPv6 Security Policy

- Access control lists
 - Configuration
 - Implicit Rules
- Interface and VTY filtering
- IPv6 NetFlow
- Enterprise Security

Cisco IOS IPv6 Extended Access Control Lists

- ❑ **Very much like in IPv4**
 - Filter traffic based on
 - ❑ Source and destination addresses
 - ❑ Next header presence
 - ❑ Layer 4 information
 - Implicit deny all at the end of ACL
 - Empty ACL means traffic allowed
 - Reflexive and time based ACL
- ❑ Known extension headers (HbH, AH, RH, MH, destination, fragment) are scanned until:
 - Layer 4 header found
 - Unknown extension header is found

IPv6 ACL Implicit Rules

RFC 4890

- Implicit entries exist at the end of each IPv6 ACL to allow neighbour discovery:

```
permit icmp any any nd-na  
permit icmp any any nd-ns  
deny ipv6 any any
```

IPv6 ACL Implicit Rules:

Adding a deny-log

- ❑ The IPv6 beginner's mistake is to add a 'deny log' at the end of the IPv6 ACL

```
. . .  
! Now log all denied packets  
deny IPv6 any any log  
! Oooops . . . I forget about these implicit lines  
permit icmp any any nd-na  
permit icmp any any nd-ns  
deny ipv6 any any
```

- ❑ Instead, explicitly add the implicit ACL

```
. . .  
! Now log all denied packets  
permit icmp any any nd-na  
permit icmp any any nd-ns  
deny ipv6 any any log
```

To filter ICMPv6 or not?

- ❑ Many administrators are very accustomed to severely filtering ICMPv4
 - Due to history – the ICMP DoS attacks from the late 90s and early 2000s.
 - Blocking all ICMPv4 doesn't really hurt IPv4 too much
 - ❑ Stops Path MTU Discovery
 - ❑ Makes troubleshooting incredibly hard
- ❑ Severely filtering ICMPv6 will cause serious harm to IPv6, if not preventing IPv6 from working
 - RFC4890 filtering *or*
 - Rate-limit ICMPv6 and allow it all

Example: RFC 4890 ICMP ACL

```
ipv6 access-list RFC4890
  permit icmp any any echo-reply
  permit icmp any any echo-request
  permit icmp any any 1 3
  permit icmp any any 1 4
  permit icmp any any packet-too-big
  permit icmp any any time-exceeded
  permit icmp any any parameter-problem
  permit icmp any any mld-query
  permit icmp any any mld-reduction
  permit icmp any any mld-report
  permit icmp any any nd-na
  permit icmp any any nd-ns
  permit icmp any any router-solicitation
```

Example: Rogue RA & DHCP ACL

- If rogue RA or rogue DHCP server detected on network, how to deal with it?

```
ipv6 access-list ACCESS-PORT
  remark Block all traffic DHCP server -> client
  deny udp any eq 547 any eq 546
  remark Block Router Advertisements
  deny icmp any any router-advertisement
  permit any any

interface gigabitethernet 1/0/1
  switchport
  ipv6 traffic-filter ACCESS-PORT in
```

IPv6 ACL to Protect VTY

- Protecting router VTYS is very important
 - Remember: device security is as good as the least protected protocol

```
ipv6 access-list VTY
 permit ipv6 2001:db8:0:1::/64 any
!
line vty 0 4
 ipv6 access-class VTY in
```

IPv6 Filtering

- IPv6 access-lists (ACL) are used to filter traffic and restrict access to the router
 - Used on router interfaces
 - Used to restrict access to the router
 - ACLs matching source/destination addresses, ports and various other IPv6 options
- IPv6 prefix-lists are used to filter routing protocol updates
 - Used on BGP peerings
 - Matching source and destination addresses

IPv6 prefix-list example

- Example of using an ipv6 prefix-list to filter prefixes on a BGP session:

```
router bgp 10
  neighbor 2001:db8:1:1019::1 remote-as 20
  !
  address-family ipv6
    neighbor 2001:db8:1:1019::1 activate
    neighbor 2001:db8:1:1019::1 prefix-list ipv6-ebgp in
    neighbor 2001:db8:1:1019::1 prefix-list v6out out
    network 2001:db8::/32
  exit-address-family
  !
  ipv6 prefix-list ipv6-ebgp permit ::/0 le 128
  !
  ipv6 prefix-list v6out permit 2001:db8::/32
  !
```

Cisco IOS IPv6 NetFlow

- Netflow supports IPv6 as from IOS 12.4
 - Type 9 flow records
 - Following syntax in 12.4 IOS releases
- Activated by:
 - Interface subcommands:
 - `ipv6 flow ingress`
 - `ipv6 flow egress`
- Status:
 - `show ipv6 flow cache`

IPv6 NetFlow

```
gw>show ipv6 flow cache
```

```
IP packet size distribution (520293627 total packets):
```

```
1-32   64   96  128  160  192  224  256  288  320  352  384  416  448  480
.000 .837 .130 .031 .000 .000 .000 .000 .000 .000 .000 .000 .000 .000 .000
```

```
512   544   576 1024 1536 2048 2560 3072 3584 4096 4608
.000 .000 .000 .000 .000 .000 .000 .000 .000 .000 .000
```

```
IP Flow Switching Cache, 475168 bytes
```

```
29 active, 4067 inactive, 11258417 added
```

```
293481382 age polls, 0 flow alloc failures
```

```
Active flows timeout in 30 minutes
```

```
Inactive flows timeout in 15 seconds
```

```
IP Sub Flow Cache, 33992 bytes
```

```
0 active, 1024 inactive, 0 added, 0 added to flow
```

```
0 alloc failures, 0 force free
```

```
1 chunk, 1 chunk added
```

| SrcAddress Packets | InpIf | DstAddress | OutIf | Prot | SrcPrt | DstPrt |
|--------------------------|-------|--------------------------|-------|------|--------|------------|
| 2001:7F8:4:1::44FC:1 | Local | 2001:7F8:4:1::219F:1 | Gi0/0 | 0x06 | 0x00B3 | 0x9658 11 |
| 2001:7F8:4:1::219F:1 | Gi0/0 | 2001:7F8:4:1::44FC:1 | Local | 0x06 | 0x9658 | 0x00B3 11 |
| 2001:7F8:4:1::44FC:1 | Local | 2001:7F8:4:1::220A:2 | Gi0/0 | 0x06 | 0x00B3 | 0x8525 110 |
| 2001:7F8:4:1::44FC:1 | Local | 2001:7F8:4:1::847:1 | Gi0/0 | 0x3A | 0x0000 | 0x8800 14 |
| 2001:7F8:4:1::32E6:1 | Gi0/0 | FE80::222:55FF:FEE4:1F1B | Local | 0x3A | 0x0000 | 0x8800 256 |
| 2001:7F8:4:1::220A:2 | Gi0/0 | 2001:7F8:4:1::44FC:1 | Local | 0x06 | 0x8525 | 0x00B3 82 |
| FE80::212:F2FF:FEF2:3C61 | Gi0/0 | FE80::222:55FF:FEE4:1F1B | Local | 0x3A | 0x0000 | 0x8800 256 |
| 2001:7F8:4:1::1F8B:1 | Gi0/0 | 2001:7F8:4:1::44FC:1 | Local | 0x06 | 0x00B3 | 0x4533 4 |

Cisco IOS IPv6 Netflow (15.0+)

- Flexible Netflow from 12.4T and 15.0 software releases:

```
flow monitor FLOW-MONITOR-V6-IN
  exporter EXPORTER
  cache timeout active 300
  record netflow ipv6 original-input
!
flow monitor FLOW-MONITOR-V6-OUT
  exporter EXPORTER
  cache timeout active 300
  record netflow ipv6 original-output
!
interface GigabitEthernet0/0
  ipv6 flow monitor FLOW-MONITOR-V6-IN input
  ipv6 flow monitor FLOW-MONITOR-V6-OUT output
!
```

Cisco IOS IPv6 Netflow (15.0+)

- Show commands are more sophisticated, for example:
 - Show the top 20 outbound IPv6 flows

```
show flow monitor FLOW-MONITOR-V6-OUT cache aggregate  
ipv6 source address ip64 destination address sort counter  
bytes top 20
```

- Show the top 20 inbound IPv6 flows

```
show flow monitor FLOW-MONITOR-V6-IN cache aggregate ipv6  
source address ipv6 destination address sort counter  
bytes top 20
```

Securing IPv6 Connectivity



How do we secure our end-to-end connections...?

Securing IPv6 Connectivity

- Over Internet
 - Client to Server:
 - IPsec or SSL VPN Client Software
 - Network to Network:
 - Tunnel technology (GRE) protected by IPsec
- Site to Site VPNs
 - Tunnel technology (GRE or MPLS) protected by IPsec

Secure IPv6 over IPv4/6 Public Internet

- ❑ No traffic sniffing
- ❑ No traffic injection
- ❑ No service theft

| Public Network | Site to Site | Remote Access |
|----------------|--|-----------------------------|
| IPv4 | 6in4/GRE Tunnels Protected by IPsec | IPsec or SSL VPN Clients |
| IPv6 | GRE Tunnels Protected by IPsec | IPsec or SSL VPN Clients |

Secure Site to Site IPv6 Traffic over IPv4 Public Network with GRE IPsec

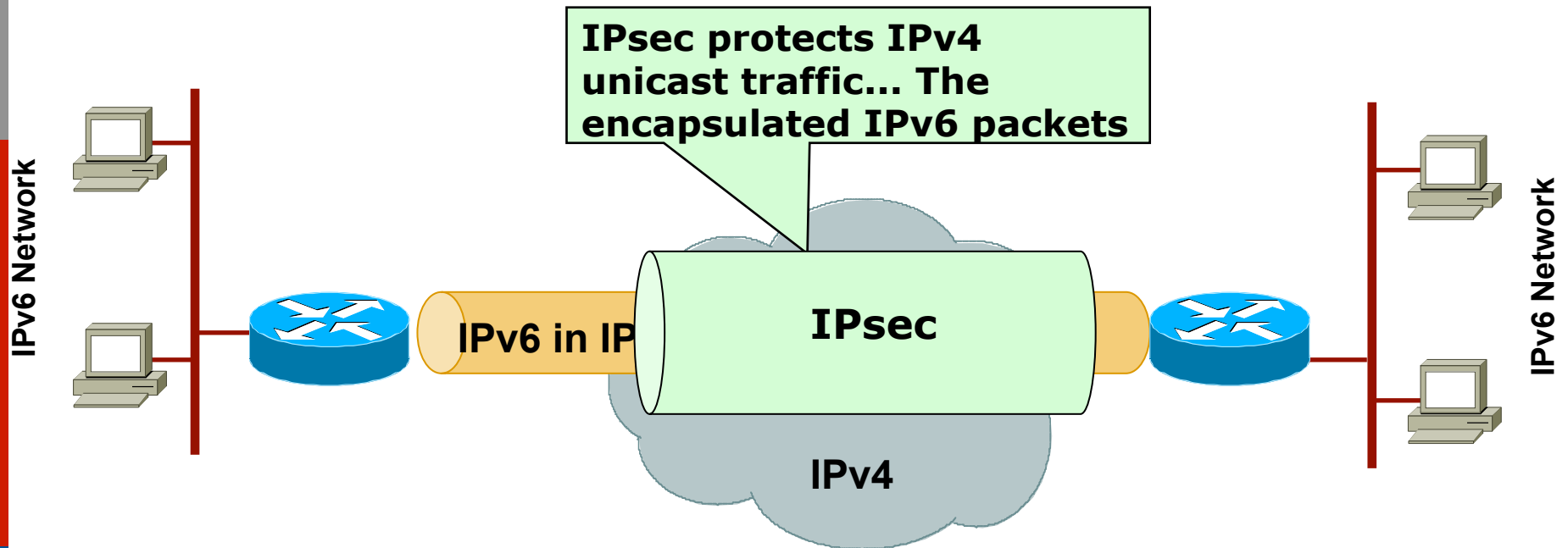

GRE tunnel can be used to transport both IPv4 and IPv6 in the same tunnel

IPv6 Security Best Practices



Recommendations...

Candidate Best Practices (1)

- ❑ Train your network operators and security managers on IPv6
- ❑ Train your network operators and security managers on IPv6

- ❑ Selectively filter ICMP (RFC 4890)
 - Might be easier to rate-limit ICMPv6 to a few Mbps
- ❑ Block Type 0 Routing Header at the edge
 - Should be automatically blocked by equipment already (but do it anyway)

Candidate Best Practices (2)

- Adopt **all** the IPv4 Best Current Practices
 - **Implement BCP38 filtering**
 - If management plane is only IPv4, block IPv6 to the core devices
 - If management plane is dual stack, replicate IPv4 filters in IPv6
 - Which extension headers will be allowed through the access control device?
 - Deny IPv6 fragments destined to network equipment when possible
 - Use authentication to protect routing protocols
 - Document procedures for last-hop traceback

Candidate Best Practices (3)

Mainly for Enterprise Customers

- ❑ Implement privacy extensions carefully
- ❑ Only allow Global Unicast address sourced traffic out the border routers
 - Block ULA and other non-assigned IPv6 addresses
- ❑ Filter unneeded services at the firewall
- ❑ Maintain host and application security
- ❑ Use cryptographic protections where critical
- ❑ Implement ingress filtering of packets with IPv6 multicast source addresses
- ❑ **Avoid tunnels**
 - If you must tunnel, use static tunneling **NOT** dynamic tunneling

Conclusion

- ❑ So, nothing really new in IPv6
- ❑ Lack of operational experience may hinder security for a while ⇒ **training is required**
- ❑ Security enforcement is possible
 - Control your IPv6 traffic as you do for IPv4
- ❑ Leverage IPsec to secure IPv6 when suitable

IPv6 Security



ISP Workshops